

TOB-002

TOBOGÁN PEHD PEQUEÑO.

Revision: 01 - 02/11/2016

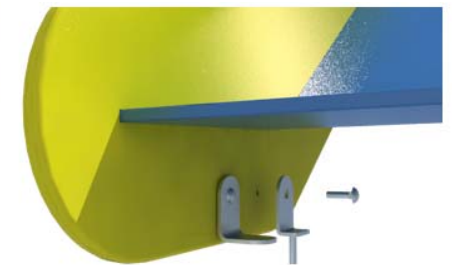
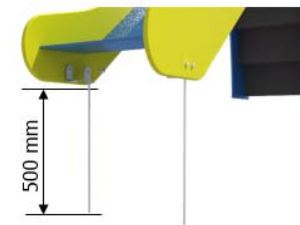
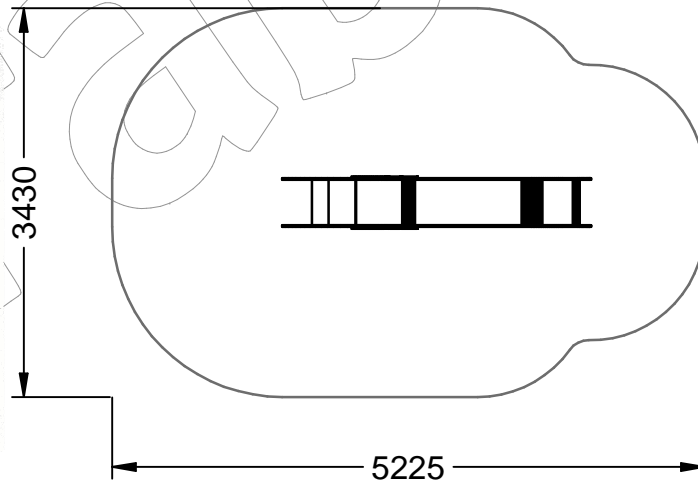
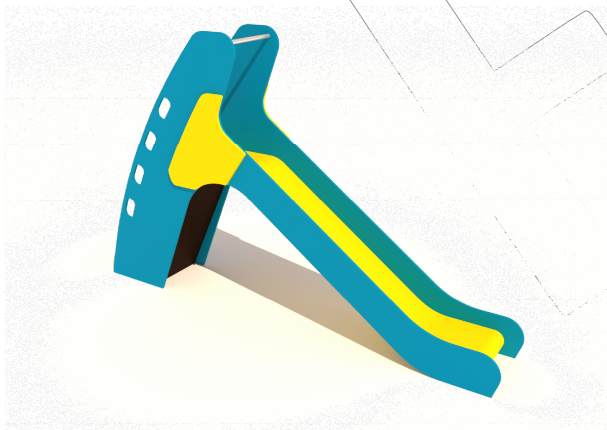
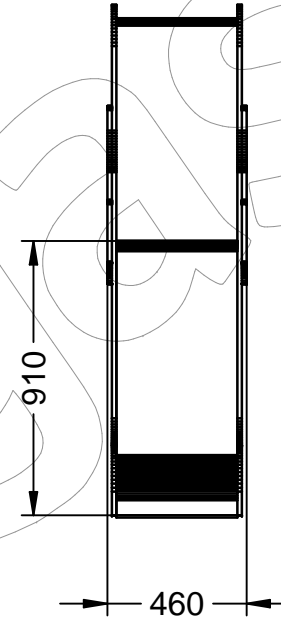
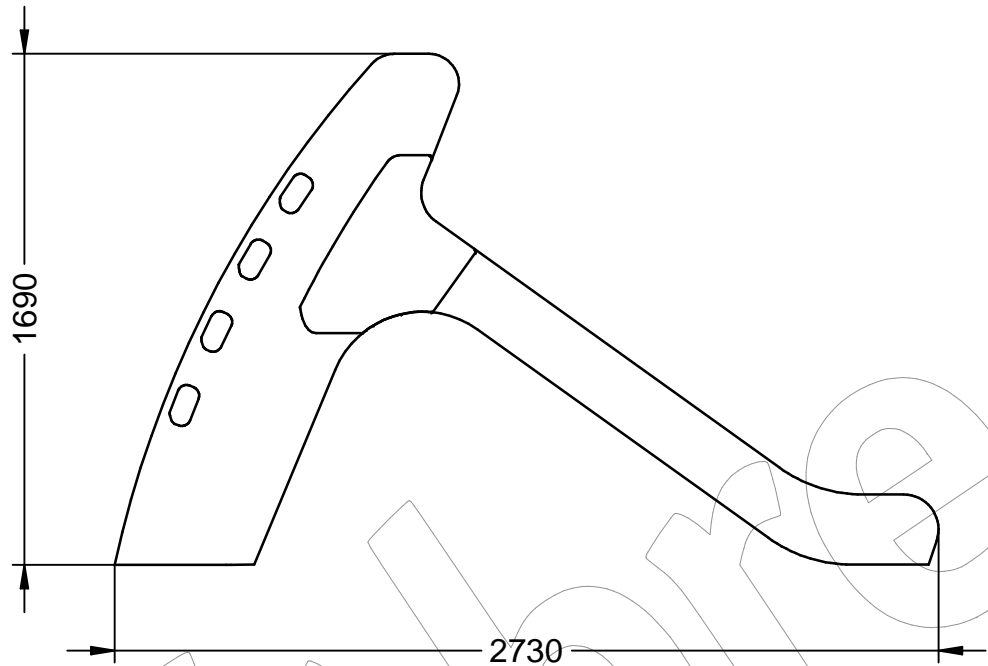

TOB-002

TOBOGÁN PEHD PEQUEÑO.

Revision: 01 - 02/11/2016

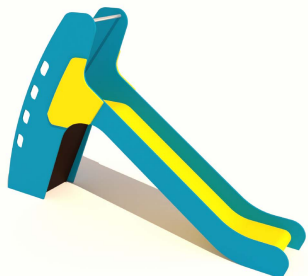

-ES-



Paneles y deslizador de polietileno.

Barra de acero inoxidable AISI 304.

Peldaños de contrachapado Fenólico antideslizante.

Tornillería galvanizada.

Medidas: 2.730 x 460 x 1.690 mm.

Zona de seguridad: 5.225 x 3.430 mm.

-EN-



Polyethylene panels and slider.

AISI 304 stainless steel bar.

Steps in non-slip phenolic plywood.

Galvanised hardware.

Measures: 2.730 x 460 x 1.690 mm.

Safety zone: 5.225 x 3.430 mm.

-PT-



Painéis de controle deslizante e polietileno.

Bar aço inoxidável AISI 304.

Fenólico de graus antiderrapantes madeira compensada.

Parafusos galvanizados.

Medidas: 2.730 x 460 x 1.690 mm.

Zona de segurança: 5.225 x 3.430 mm.

-CA-



Panells i lliscant de polietilè.

Barra d'acer inoxidable AISI 304.

Esglaons de contraxapat Fenòlic antilliscant.

Tornilleria galvanitzada.

Mesures: 2.730 x 460 x 1.690 mm.

Zona de seguretat: 5.225 x 3.430 mm.

-FR-



Panneaux et glissière en polyéthylène.

Barre en acier inoxydable AISI 304.

Marches en contreplaqué phénolique anti-dérapant.

Visserie galvanisée.

Mesures: 2.730 x 460 x 1.690 mm.

Zona de sécurité: 5.225 x 3.430 mm.