

BAS-008

Juego multiactividades CONJUNTO 4 TORRES.

Revision: 01 - 24/10/2016

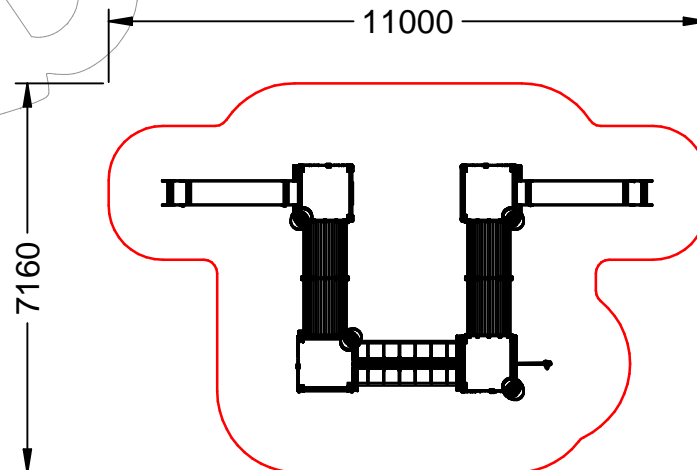
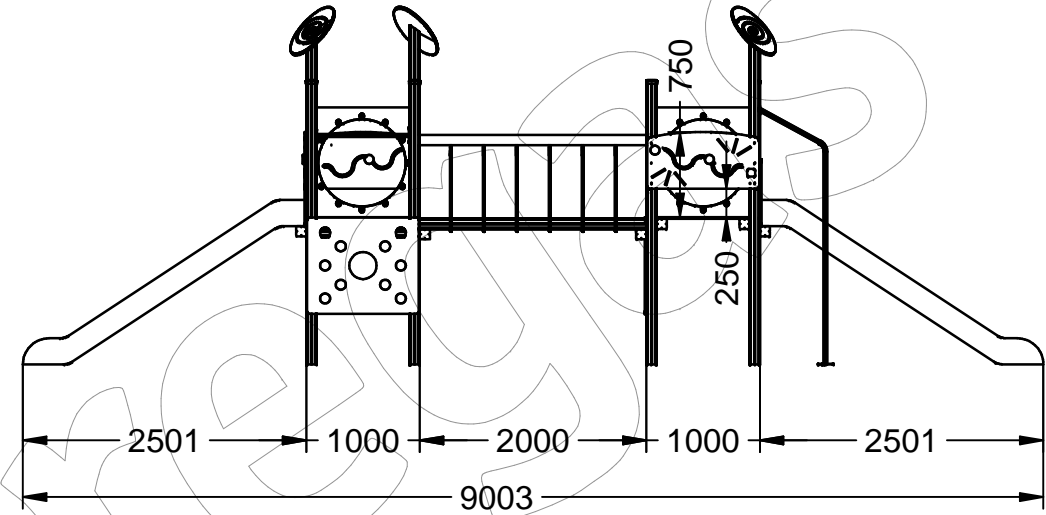
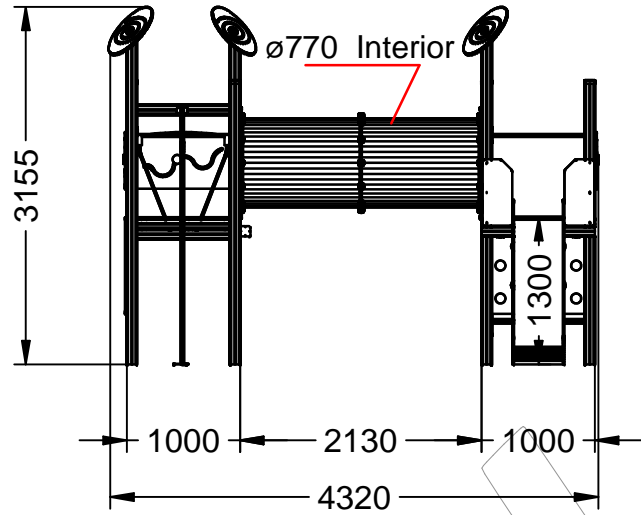

BAS-008

Juego multiactividades CONJUNTO 4 TORRES.

Revision: 01 - 24/10/2016



-ES- 

Madera laminada de pino tratada en autoclave.

Paneles y rampa PEHD de alta intensidad 15 mm.

Estructura metálica y barra de bomberos en acero INOX AISI 304.

Tornillería zincada.

Medidas: 9.003 x 4.320 x 3.155 mm.

Zona de seguridad: 7.160 x 11.000 mm.

-EN- 

Laminated pine wood treated in an autoclave.

PEHD panels and ramp of high intensity 15 mm.

Metal structure and firemen's bar in INOX AISI 304 steel.

Zinc-plated screws

Measures: 9.003 x 4.320 x 3.155 mm.

Safety zone: 7.160 x 11.000 mm.

-PT- 

Madeira laminada de pinheiro tratada em uma autoclave.

Painéis de PEHD e rampa de alta intensidade de 15 mm.

Estrutura metálica e barra de bombeiros no aço INOX AISI 304.

Parafusos zincados

Medidas: 9.003 x 4.320 x 3.155 mm.

Zona de segurança: 7.160 x 11.000 mm.

-CA- 

Fusta laminada de pi tractada en autoclau.

Panells i rampa PEHD d'alta intensitat 15 mm.

Estructura metàl·lica i barra de bombers en acer INOX AISI 304.

Tornilleria zincada.

Mesures: 9.003 x 4.320 x 3.155 mm.

Zona de seguretat: 7.160 x 11.000 mm.

-FR- 

Bois de pin laminé traité en autoclave.

Panneaux en PEHD et rampe de haute intensité 15 mm.

Structure métallique et barre de pompier en acier INOX AISI 304.

Vis zinguées

Mesures: 9.003 x 4.320 x 3.155 mm.

Zona de sécurité: 7.160 x 11.000 mm.